

CS100/CS300 Battery Operation

Quick Reference Guide

GETINGE 



Note: This is an abbreviated guide for proper battery operation and maintenance for the CS100 and CS300. For complete product instructions, please refer to the CS100 and CS300 Operating Instructions.

Introduction

This Quick Reference Guide is designed to highlight the location, functionality, alarms and maintenance of the lead acid batteries that accompany the CS100 and CS300 Intra-aortic Ballon Pumps.

The CS100 and CS300 batteries are designed to be used during transport or portable operation and it is critical to keep these batteries charged at all times to avoid interruption in power during transport. Additionally, it is important to maintain the batteries in accordance with CS100 and CS300 Operating Instructions.



CS100



CS300

Table of Contents

Section	Page #
Battery Overview	4-6
Battery Status	7-14
CS300 Battery Operation	15-20
CS300 Battery Preventive Maintenance	21
CS100 Battery Operation	22-30
CS100 Battery Preventive Maintenance	31
Key Battery Warnings and Cautions	32

CS100/CS300 Internal Battery Specifications

Type: 24 VDC (nominal), 17.2 Amp-hours
Sealed lead acid, maintenance free

Run Time: (full charge) 2.25 hours minimum (from full charge, 120 bpm, 22 ± 5 °C)
Approximately 3.0 hours typical with new battery (from full charge, 90 bpm, 22 ± 5 °C)

NOTE: A reduction in runtime can occur over a battery's life for reasons such as age, storage temperature and discharge depth.

Recharge Time: 18 hours minimum (from complete discharge to full charge, 22 ± 5 °C), 8 hours to achieve at least 90 percent charge (typically).

CS100/CS300 Battery Information

CS100/CS300 Batteries

The IABP includes a battery pack which contains two sealed lead acid batteries. The batteries are maintenance free. There is no need to add water or electrolyte. The batteries are sealed to prevent leakage from the terminals or case.

Replace batteries as required. Batteries should be replaced after 100 full discharge cycles, at no more than three (3) year intervals, or if run time is less than the minimum run time of 135 minutes minimum at 120 bpm.

Disposal of batteries should be conducted in accordance with local statutes and the labeling shown on the battery pack.

CS100/CS300 Optimum Battery Performance

To obtain optimum battery performance and expected battery life the following guidelines should be observed.

- **The batteries should be maintained at full charge when the IABP is not in use. It is required that the IABP be plugged into an AC outlet when the system is not in use. Verify the battery is charging by observing the charge indicator on the pump module. If the unit must be stored for an extended time period (2 months or longer) and AC power is not available to maintain the internal battery, or if the unit is stored in an ambient exceeding the maximum operating temperature, disconnect the system battery pack from the system console. Due to battery self-discharge the disconnected batteries must be fully recharged at least every four months.**
- The battery contains a safety vent that will allow gases to be released should its rating be exceeded. If this vent is actuated do not operate the unit and contact a qualified service representative.
- Do not short circuit the battery or battery pack terminals. Keep battery pack covers on at all times to avoid objects or liquids falling on batteries.
- Excessive heat is very detrimental to battery life. Do not operate the system in ambients above the maximum operating temperature.
- DO NOT attempt to repair the battery. If the case is cracked or terminal leads are broken replace with the same rate battery.
- DO NOT disassemble battery. The battery contains an electrolyte which can injure skin or damage clothing. In the event that electrolyte gets on skin or in eyes, immediately flush with water for 15 minutes and get prompt medical attention.
- Batteries must be replaced as pairs, (i.e., same lot/date code).
- When a **Low Battery** message is displayed after any system operation, the battery should be recharged within several hours to prevent battery damage

It is extremely important to know the status of the IABP batteries at all times, as the status of the internal batteries affects the performance and operation of the unit. There are two ways to determine the battery status, on the front panel and on the display screen.

Viewing Battery Status on Front Panel

IABP ON/OFF

This is the ON/OFF switch for the IABP console and monitor module. Operation of this switch does not affect the status of the internal battery charger.

Battery Charging LED

This indicator has three states:

- It illuminates continuously when the internal batteries are fully charged
- The LED indicator flashes when the internal batteries are charging
- **CS300:** It is not illuminated when system is using the battery as a power source, or when AC power is not available to the system, or when the system battery is faulty.
- **CS100:** The **Battery In Use** status message and the **Battery Indicator** are displayed when the system is operating from the internal rechargeable battery.

FOR CS300:



CAUTION: The system should be configured to charge the internal batteries whenever AC power is available. Hence, keep the system connected to a live AC receptacle with the Mains On/Off switch in the "On" position. If the system is to be stored for extensive periods of time, or in ambient temperatures above the operating range, see the Battery Section of the User Maintenance Chapter in the Operating Instructions for additional information.

CAUTION: When AC power operation is intended, insure that the system is plugged into AC mains, that the mains switch is in the "On" position, and that the Battery In Use informational message is NOT displayed.

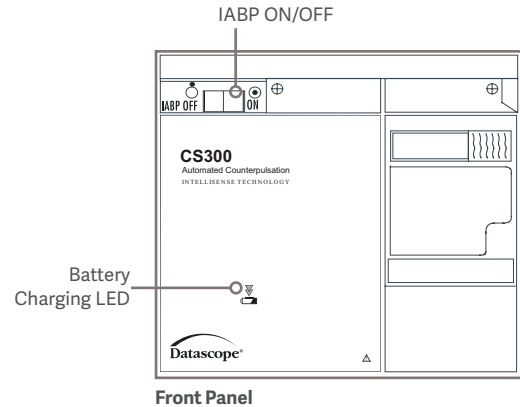

FOR CS100:



CAUTION: The internal batteries are charging only when the AC Mains plug is connected to an active AC Mains source, the AC Mains switch is "On", and the battery charging status LED is illuminated. This charging condition must be maintained even when the system is not in use. Note that 18 hours of charging is required to fully charge the batteries.

Viewing Battery Status on Display Screen

Alarm and Advisory Messages Area

This section of the screen displays alarm and advisory messages. The top-most line is reserved for high priority alarms. The lower three (3) lines are shared to display any medium/low level alarms or informational messages. If more than one message is displayed, they are posted in priority order. See Alarms and Advisory Messages on page 9 of this document, for more information regarding priority. As conditions are corrected, the corresponding message is cleared and the next highest priority alarm or informational message is displayed. Pressing the HELP key will access the appropriate help screen for the displayed condition. See “Help Screens” in the Operating Instructions for more information.

Battery Indicator Icon

This icon indicates the approximate charge remaining in the internal batteries. This indicator is displayed only when the system is powered by the internal batteries.



Battery

NOTE: The Low Battery Medium Priority Alarm is displayed when less than 30 minutes (approximately) of internal battery life remains. When this message appears, the battery symbol is displayed as empty and starts flashing. See the Troubleshooting and User Maintenance Chapters in the Operating Instructions for additional information.

BATTERY IN USE

Associated Help Screen

Probable Cause

The IABP is being powered from the internal batteries.

Corrective Actions

1. Verify that it is necessary to operate from the internal battery. If appropriate, switch to the AC power source.
2. Verify MAINS power switch, located above the AC power cord connector, is ON.

CAUSE AND RESPONSE:

Operation Trigger Mode	Trigger Source	Detailed Cause	System Response	Reset
All	All	Indicates System is operating from an internal battery.	Unaffected	Message clears when power is received from AC power source.

Note: The display shown is for illustrative purposes and does not represent actual clinical conditions.

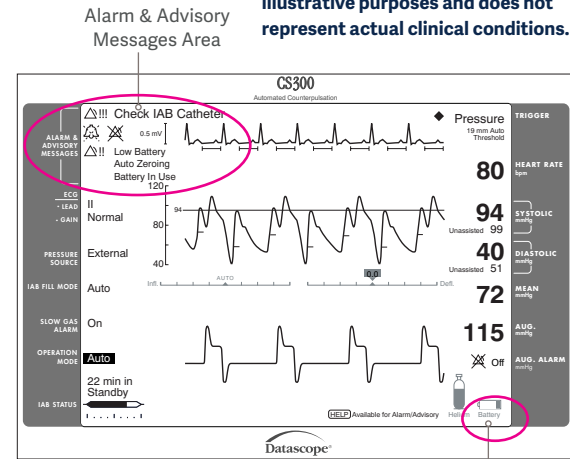

Display Screen

Battery Indicator Icon

Battery Alarms and Advisory Messages

The IABP utilizes both auditory and visual alarm signals to communicate the need for attention or awareness by the pump operator. Auditory alarm signals (tone sequences) are primarily intended to attract the attention of the operator. They were carefully developed to communicate the urgency of the response, as well as the pump's location. Auditory signals are effective over a relatively broad range of operator positions.



CAUTION: Do not set the alarm volume to such a low level that it cannot be readily heard over the ambient noise level of the venue in which the IABP is used.

Visual alarm signals consist of both display panel symbols and text. The displayed information further reinforces the urgency of the alarm (symbol shape, color & flashing property) and also identifies the alarm via a specific text message. Textual information is legible at the operator's position, up to 1 meter from the front of the display panel.

Additionally, alarms are further complimented by an option to display context sensitive help information to aid in the understanding and guide in the resolution of the alarm condition.

Alarm and advisory messages are grouped into the following categories in order to facilitate operator awareness and understanding:

- Technical Alarms
- High, Medium and Low Priority Alarms
- Informational Messages.

These messages are displayed based upon the priority of the condition(s) that prompted them. Technical Alarms and High Priority Alarm messages are displayed in the top line of the Alarm and Advisory Messages section of the display.

Medium/low level alarms or informational messages are displayed in the 3 lines below the top line. When a Medium Priority Alarm – such as a Battery Alarm – is displayed, IAB assist is not suspended and the Medium Priority Alarm tone is sounded. Medium Priority Alarms require the Operator's prompt response.

Medium Priority Alarms

Medium Priority Alarms indicate situations in which a prompt Operator response is required. This class of alarm does not suspend pumping but may indicate a need for corrective action. A yellow flashing alarm icon with two (2) exclamation points denotes Medium Priority Alarms.

All Medium Priority Alarms have a uniform audio tone. The combination of three (3) notes for Medium Priority Alarms is played in the following sequence: three notes apause and then this cycle repeats.

NOTE: A “Low Battery” is categorized as a Medium Priority Alarm.



Medium Priority Alarm Icon

Low Battery Alarm and Help Screen Message

Help screens are provided to guide the user through set-up procedures and for consultation regarding alarm or informational message descriptions and alarm configuration. Help Screens are context sensitive and available based on the information displayed on the screen. For example: The help screens for initial set-up are only available at power-up and cleared once pumping is initiated. Similarly, the help screens for alarm messages are only available while an alarm condition or informational message exists.

The following is the associated help screen for the battery-related Medium Priority Alarm:

LOW BATTERY

Associated Help Screen

Probable Cause

There is less than 30 minutes of battery operating time remaining.

Corrective Actions

1. Verify MAINS power switch, located above the AC power cord connector, is ON.
2. Connect system to an AC power outlet.

CAUSE AND RESPONSE:

Operation Trigger Mode	Trigger Source	Detailed Cause	System Response	Reset
All	All	Battery reserve falls below 30 minutes of operating time.	Unaffected	Automatically removes message and turns off tone when AC is restored.

Informational Messages

Informational Messages provide system information to the Operator. Informational Messages display textual messages and, in some cases, are accompanied by an infrequently-repeating audio reminder tone.

The following are the associated help screens for battery-related Informational Messages:

BATTERY IN USE

Associated Help Screen

Probable Cause

The IABP is being powered from the internal batteries.

Corrective Actions

1. Verify that it is necessary to operate from the internal battery. If appropriate, switch to the AC power source.
2. Verify MAINS power switch, located above the AC power cord connector, is ON.

CAUSE AND RESPONSE:

Operation Trigger Mode	Trigger Source	Detailed Cause	System Response	Reset
All	All	Indicates System is operating from an internal battery.	Unaffected	Message clears when power is received from AC power source.

Informational Messages

BATTERY MAINTENANCE REQUIRED

Associated Help Screen

Probable Cause

The IABP internal battery requires maintenance.

Corrective Actions

1. Contact Getinge Service.
2. Continue operation on AC power.
3. If battery operation is necessary, battery run time may be reduced. Monitor the system for a Low Battery alarm.

NOTE: If a Low Battery alarm occurs, immediately connect the system to AC power.

CAUSE AND RESPONSE:

Operation Mode	Trigger Source	Detailed Cause	System Response	Reset
All	All	The Battery Test Due Date or Battery Replacement Date predate the current system date at startup or the internal battery has a total accumulated discharge time in excess of 100 total discharge cycles.	None	At startup the message is cleared when the START key is pressed. During operation the message is removed after 30 seconds.

Informational Messages

BATTERY MAINTENANCE REQUIRED

Associated Help Screen

Probable Cause

The internal battery has become unreliable.

Corrective Actions

1. Contact Getinge Service. Battery replacement may be required.
2. Continue operation on AC power.
3. If battery operation is necessary, battery run time may be reduced. Monitor the system for a Low Battery alarm.

NOTE: If a Low Battery alarm occurs, immediately connect the system to AC power.

CAUSE AND RESPONSE:

Operation Mode	Trigger Source	Detailed Cause	System Response	Reset
All	All	The internal battery failed to reach a satisfactory level of charge within 10 hours.	None	At startup the message is cleared when the START key is pressed. During operation the message is removed after 1 minute.

Introduction for CS300

The IABP is available in two versions: the 'Standard' or 'Hospital' version, which is optimized for in-hospital usage; and the UTS (Universal Transport System) version, which is optimized for vehicular transport. The differences between the two versions are described later in this chapter. Both versions have the same therapeutic capabilities, and both have built-in battery packs, which automatically power the unit if AC power is not available

CS300 Hospital Cart

The IABP console is mounted on a hospital cart for intra-hospital transport. The console may be separated from the cart to accommodate very tight spaces within a hospital room/venue.

All four (4) casters on the hospital cart swivel to facilitate movement in any direction. The two casters closest to the cart handle are multifunctional. They can be locked in the straight position (directional lock) or used as a brake (total lock). The two casters on the side opposite the handle have total lock only. It is recommended that all four casters are locked for use on uneven surfaces or in transport vehicles.

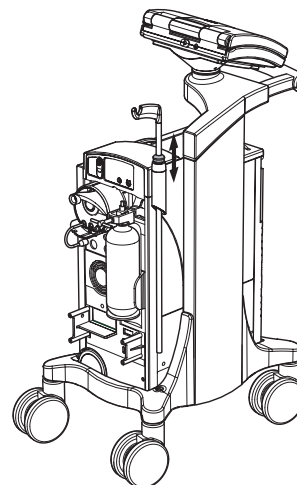

IABP Console on a
Hospital Cart

CS300 Portable Operation

The following is recommended by Datascope:

1. Battery fully charged prior to starting transport.
2. The use of Datascope's Sensor IAB will eliminate the pressure waveform artifact that commonly occurs when moving patients using conventional fluid-filled pressure monitoring catheters. Altitude changes are compensated for automatically in the **Autofill** mode or manually in the **Manual Fill** mode.
3. The system must be properly secured when used in an ambulance, helicopter, or fixed wing aircraft.

The Universal Transport System (UTS) is specifically designed for air and vehicular transport. The UTS version mechanically attaches to a docking station for high strength mounting.



WARNING: The user should continually rely on visual alarm messages during high noise transport situations.

CS300 Battery Operation

The system automatically switches to battery power if AC power is not available (intentionally or due to power loss). When AC power is restored, the system automatically reverts from internal battery operation to AC Mains usage. The internal battery pack charges while the system operates from AC Mains power.

Prior to portable operation, the battery should be fully charged. A fully charged battery is indicated by a continuously illuminated battery-charging LED (located on the front panel).



WARNING: Disconnecting the internal battery, when AC mains are not connected, will stop the therapy, (i.e., power down the pump.)



CAUTION: When AC power operation is intended, insure that the system is plugged into AC mains, that the mains switch is in the “On” position, and that the “Battery in Use” informational message is NOT displayed.



CAUTION: System batteries must be properly maintained and periodically tested.



CAUTION: The system should be configured to charge the internal batteries whenever AC power is available. Hence, keep the system connected to a live AC receptacle with the Mains On/Off switch in the On position. If the system is to be stored for extensive periods of time, or in ambient temperatures above the operating range, see the Battery Section of the User Maintenance Chapter in the Operating Instructions for additional information.

CS300 Battery Operation

Battery in Use

- Verify that the “Battery in Use” Informational Message and the Battery Indicator are displayed when in battery operation.
- Battery charging is not active when the battery is in use.
- When the battery has approximately 30 minutes of operating time remaining, the following occurs:
 - The Medium Priority Alarm tone is activated.
 - The “Low Battery” Medium Priority Alarm message is displayed on the screen continuously.
 - The Battery Indicator is displayed as empty and it starts flashing.
 - The condensate removal module will not operate (to conserve remaining power).

A reduction in run time will occur over a battery's life due to age, storage temperature and discharge cycles. Batteries which are continually subjected to complete discharge cycles without the recommended immediate recharging, can incur permanent damage.

CS300 Operation from DC-to-AC Inverter

The IABP can be powered from a DC-to-AC inverter if the DC source and the inverter meet the specifications defined below. The DC source and inverter should be checked for proper operation by qualified maintenance personnel prior to emergency use. The message Battery in Use will not be displayed during proper AC inverter operation.

Specifications for DC Source and Inverter for Use with the IABP

Voltage Output:	100-120/220-240 VAC \pm 1 0%
Frequency:	50 Hz \pm 2 Hz, 60 Hz \pm 2 Hz
Overshoots:	Does not continuously generate overshoots greater than 375 Volts peak with widths greater than 10 mSec when powering the system
Waveform:	Sine wave or modified sine wave
Output Capability:	Minimum of 500 watts continuous power; 1000 watts surge power
Safety Compliance:	Meets or exceeds safety standards per IEC 60601-1

Removing CS300 Pump Console from the Cart (with battery pack attached)

The console can be removed from the cart with or without the battery pack attached. Removing the console without the battery pack attached reduces the lift weight by approximately 35 lbs.



CAUTION: Insure that the wheels of the cart are in the locked position when removing the pump console from the cart or returning the pump console to the cart.

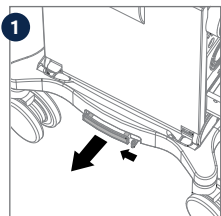

1
Unlock console by pressing tab to right of console release handle and pull handle straight out.

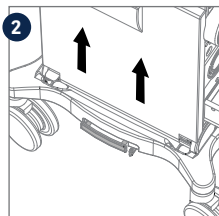

2
Lift pump console straight up and off cart.

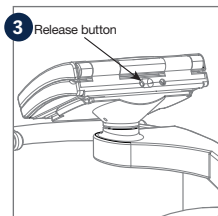

3
Detach monitor from cart handle by pressing button on rear of monitor.

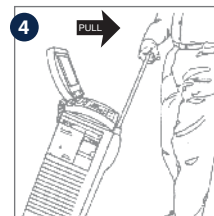

4
Attach monitor to top of pump console. Extend console handle until it locks, tilt pump and pull to transport.



CAUTION: When transporting the system without the cart, be sure to only pull the system by the handle, DO NOT PUSH.



CAUTION: The pull up handle must not be used to lift the unit. Use only designated lift points and handles.

CS300 Preventive Maintenance

Two preventive maintenance schedules have been provided.

Schedule A indicates which actions should be taken by either the Clinical User or by a Biomedical Technician (BMET). These steps do not require the use of tools and may be performed in a clinical setting.

Schedule B indicates the actions which should be performed only by a BMET or other qualified service personnel. Tools are required and in some cases the instrument covers must be removed.



WARNING: Preventive Maintenance should not be performed when the IABP is attached to a patient.



CAUTION: This product requires scheduled preventative maintenance in order to maintain its specified performance. Note that maintenance includes periodic cleaning to assure that proper cooling airflow of the system's electronics is maintained.

Schedule A

To be performed by the clinical user or the BMET.

Required Action	INTERVAL			
	Before or After Each Use	Every Month	Every 6 Months	Every 1000 Hrs. of Use or 2 Years*
Before each use, ensure that the Battery Charging LED is illuminated; or, if batteries are in use, that the Battery Icon shows a full battery. See page 7 of this document.	●			

Before each use, ensure that the Battery Charging LED is illuminated; or, if batteries are in use, that the Battery Icon shows a full battery. See page 7 of this document.

* Whichever comes first

Schedule B

To be performed by the BMET.

Required Action (REFER TO SERVICE MANUAL)	INTERVAL		
	Every 6 Months	Every 2500 Hours	Every 5000 Hours
check battery for rated voltage and check battery run time. Replace batteries when operating time is marginal or after three (3) years.*	●		

check battery for rated voltage and check battery run time. Replace batteries when operating time is marginal or after three (3) years.*

* This does not imply a three-year warranty.

CS100 Hospital Cart

The **CS100** console is mounted on a hospital cart for intra-hospital transport. The console may be separated from the cart to accommodate very tight spaces within a hospital room/venue.

All four (4) casters on the hospital cart swivel to facilitate movement in any direction. The two casters closest to the cart handle are multifunctional. They can be locked in the straight position (directional lock) or used as a brake (total lock). The two casters on the side opposite the handle have total lock only.

NOTE: The casters on the handle side of the cart may or may not have a braking feature. Refer to markings on the casters.

It is recommended that all four casters are locked for use on uneven surfaces or in transport vehicles.

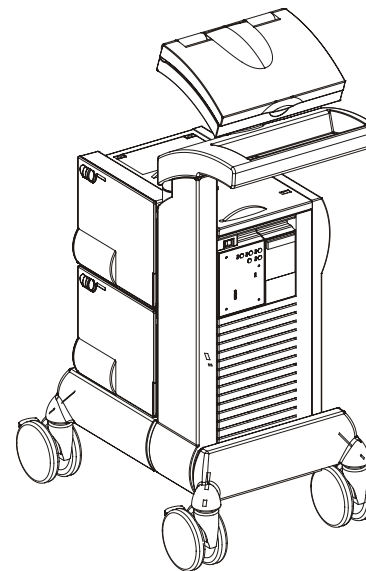

CS100 Console on a
Hospital Cart

CS100 Portable Operation

The following is recommended by Datascope during portable operation:

1. Battery fully charged prior to starting transport.
2. Altitude changes are compensated for automatically in the **Autofill** mode or manually in the **Manual Fill** mode.
3. The system must be properly secured when used in an ambulance, helicopter, or fixed wing aircraft.

The **CS100** is available in two versions with identical clinical functionality. A console version with a hospital cart or the **CS100** Universal Transport System (UTS) is specifically designed for air and vehicular transport. The UTS version mechanically attaches to a docking station for high strength mounting.



WARNING: The user should continually rely on visual alarm messages during high noise transport situations. The “Flash Alarms” option should be turned ON to improve the visibility of alarm messages. This option can be set in the User Preferences Menu (located in the Display Preferences submenu.)

CS100 Battery Operation

During portable operation, the **CS100** is powered by a rechargeable battery. Prior to portable operation the battery should be fully charged. A fully charged battery is indicated by a continuously illuminated battery charging LED. This LED is located on the front panel.

The **Battery In Use** status message and the **Battery Indicator** are displayed when the **CS100** is operating from the internal rechargeable battery. When the battery has approximately 30 minutes of operating time remaining, the following occurs:

- An audible double beep alarm is activated for 30 seconds
- The Low Battery or Low Battery (EXT) (CS 100i only) alert messages are displayed on the screen continuously
- The Battery Indicator is displayed as empty and it starts flashing
- The condensate removal module will not operate

CS100 Battery Charging

To charge the internal battery:

1. Leave the system power cord plugged in and set the MAINS On/Off to **ON**.
2. Check that the Battery Charging LED is illuminated (continuously or flashing depending on state).
3. Allow a minimum of 18 hours to fully charge a low battery. Allow 8 hours to achieve at least 90 percent charge (typically).
4. A fully-charged new internal battery will provide at least 135 minutes of portable operation.

NOTE: A reduction in run time will occur over a battery's life due to age, storage temperature and discharge depth. Batteries which are continually subjected to complete discharge cycles without the recommended immediate recharging, can incur permanent damage.

CS100 Switching from AC to Battery Operation

1. The system automatically switches to battery power if AC power is removed (intentionally or due to power loss).
2. If necessary, charge the battery as described in accordance with previous instructions.
3. Verify that the **BATTERY IN USE** advisory message and the Battery Indicator are displayed.

NOTE: Battery charging is not active in this state.

4. When AC power is restored the system automatically reverts from internal battery operation to AC Mains usage. The internal battery pack will resume charging while the system operates from AC Mains power. Always verify that the Battery Charging LED is continuously illuminated or flashing.

Operation From External DC Source (CS100i only)

In this case, the System is to be powered from an external DC source such as may be available from an ambulance, helicopter, or external battery pack.

1. Connect a voltage-compatible external source to the External DC Input connector.
2. Internal battery will not be charged in this mode.
3. The IABP ON/OFF switch will activate the system.
4. Interruption of the external DC source power will result in portable internal battery operation.
5. The internal BATTERY INDICATOR will not be displayed during external DC operation.

Operation from DC-to-AC Inverter

The CS100 can be powered from a DC-to-AC inverter if the DC source and the inverter meet the specifications defined below. The DC source and inverter should be checked for proper operation by qualified maintenance personnel prior to emergency use. The message Battery in Use will not be displayed during proper AC inverter operation.

Specifications for DC Source and Inverter for Use with the CS100

Voltage Output:	100-120/220-240 VAC \pm 10%
Frequency:	50 Hz \pm 2 Hz, 60 Hz \pm 2 Hz
Overshoots:	Does not continuously generate overshoots greater than 375. Volts peak with widths greater than 10 mSec when powering the system.
Waveform:	Sine wave or modified sine wave
Output Capability:	Minimum of 500 watts continuous power; 1000 watts surge power
Safety Compliance:	Meets or exceeds safety standards per IEC 60601-1.

Portable Operation Emergency Battery Back Up Recommendations

Datascope recommends that a back-up to the internal battery always be available.



WARNING: Replacing the internal battery, when AC mains are not connected, will stop the therapy, (i.e., power down the pump.)

Removing CS100 Pump Console from the Cart (with battery pack attached)

The console can be removed from the cart with or without the battery pack attached. Removing the console without the battery pack attached reduces the lift weight by approximately 35 lbs.



CAUTION: Insure that the wheels of the cart are in the locked position when removing the pump console from the cart or returning the pump console to the cart.

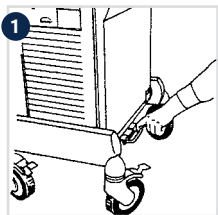

1 Unlock console by pressing tab to right of console release handle and pull handle straight out.

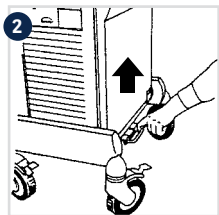

2 Lift pump console straight up and off cart.



3 Detach monitor from cart handle by pressing button on rear of monitor.

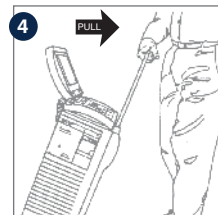

4 Attach monitor to top of pump console. Extend console handle until it locks, tilt pump and pull to transport.

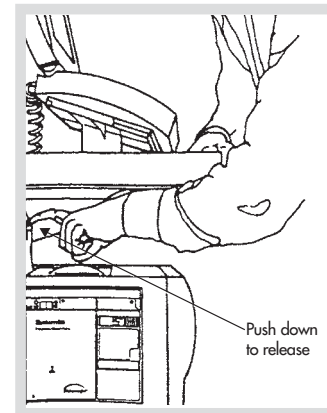

Push down to release

CS100/100i Preventive Maintenance

Two preventive maintenance schedules have been provided.

Schedule A indicates which actions should be taken by either the Clinical User or by a Biomedical Technician (BMET). These steps do not require the use of tools and may be performed in a clinical setting.

Schedule B indicates the actions which should be performed only by a BMET or other qualified service personnel. Tools are required and in some cases the instrument covers must be removed.



WARNING: Preventive Maintenance should not be performed when the IABP is attached to a patient.

Schedule A

To be performed by the clinical user or the BMET.

Required Action	INTERVAL			
	Before or After Each Use	Every Month	Every 6 Months	Every 1000 Hrs. of Use or 2 Years
Check battery system Check Battery Indicator	●			
Check battery run time. Replace batteries when operating time is marginal.			●	

* Whichever comes first.

Schedule B

To be performed by the BMET.

Required Action (REFER TO SERVICE MANUAL)	INTERVAL		
	Every 6 Months	Every 2500 Hours	Every 5000 Hours
Check battery for rated voltage and check battery run time. Replace batteries when operating time is marginal or after three (3) years.	●		

* This does not imply a three-year warranty.

Warnings and Precautions

 **WARNING:** The patient balloon should not remain inactive in the patient (i.e., no inflating and deflating) for more than 30 minutes, due to the potential for thrombus formation.

 **CAUTION:** The internal batteries are charging only when the AC Mains plug is connected to an active AC Mains source, the AC Mains switch is ON, and the battery charging status LED is illuminated. This charging condition must be maintained even when the system is not in use.

 **CAUTION:** System batteries must be properly maintained and periodically tested.

 **CAUTION:** The system should be configured to charge the internal batteries whenever AC power is available. Hence, keep the system connected to a live AC receptacle with the Mains On/Off switch in the On position. If the system is to be stored for extensive periods of time, or in ambient temperatures above the operating range, see the Battery Section of the User Maintenance Chapter in the Operating Instructions for additional information.

 **CAUTION:** Prior to emergency use, when the system is to be powered from an AC inverter, the inverter should be checked for proper operation with the system by qualified maintenance personnel. The message "Battery in Use" will not be displayed during proper AC inverter operation.

 **CAUTION:** When the optional Protective Cover is on, do not leave the IABP on and powered-up (i.e., with the IABP On/Off switch in the ON position).



PN: 0002-08-9867 Rev A · MCV00091613 REVA · ***GETINGE** ✱, Getinge, and Maquet are trademarks or registered trademarks of Getinge AB, its subsidiaries, or affiliates in the United States or other countries · Maquet is registered with the U.S. Patent and Trademark Office · STATLOCK is a registered trademark of C.R. Bard, Inc. · Copyright 2019 Datascope Corp. · All rights reserved · CAUTION: Federal (U.S.A.) law restricts this device to sale, distribution and use by or on the order of a physician. △Refer to Instructions for Use for current indications, warnings, contraindications and precautions · 05/2019

Getinge · 1300 MacArthur Blvd., Mahwah, NJ 07430 · USA · +1 201 995-8700 or 1 800 777-4222
45 Barbour Pond Drive, Wayne, NJ 07470 · USA · +1 888 880-2874

www.getinge.com